



ResMed

AirFit™ N20

Nasal mask



User guide
English

Fitting / 配戴 / 配戴 / Pemasangan

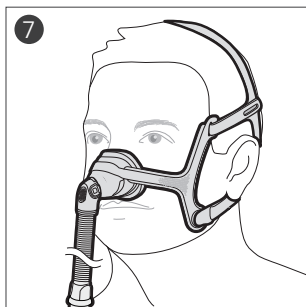
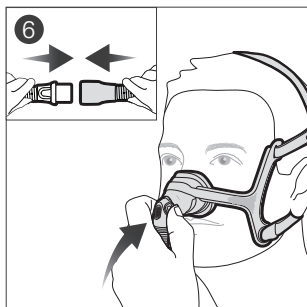
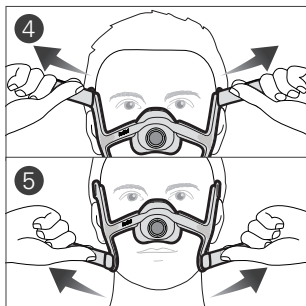
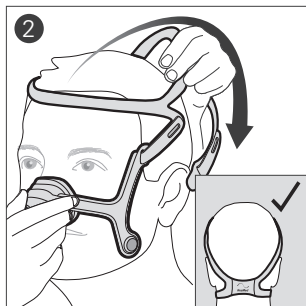
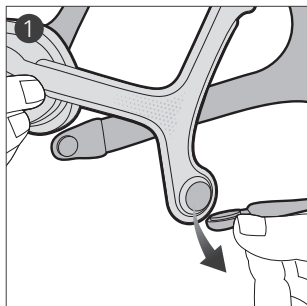

Adjustment / 调整 / 調整 / Penyesuaian

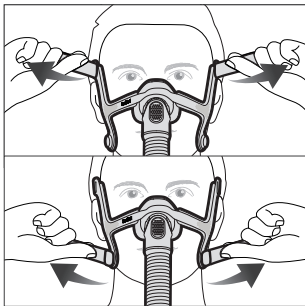
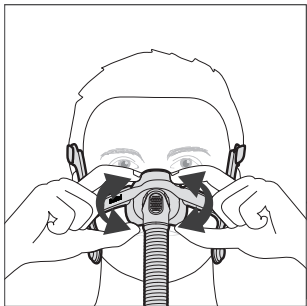

Removal / 取下面罩 / 取下面罩 / Penanggalan

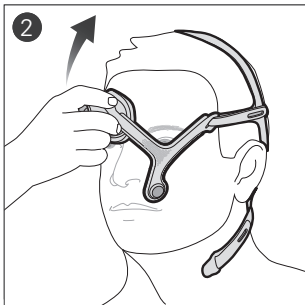
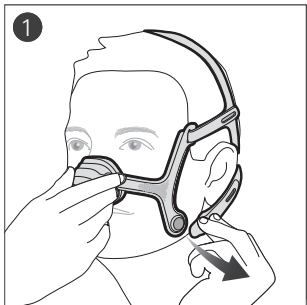

Disassembly / 拆卸 / 拆卸 / Menyahpasang

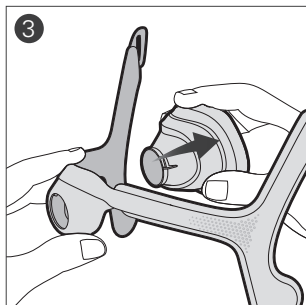
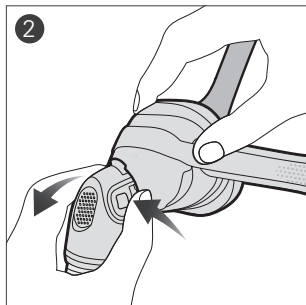
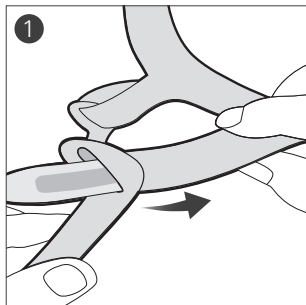

Reassembly / 重新組裝 / 重新組裝 / Pemasangan semula

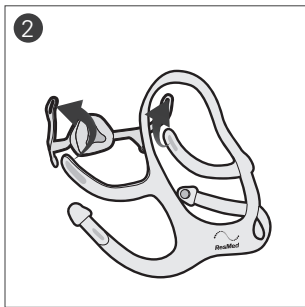
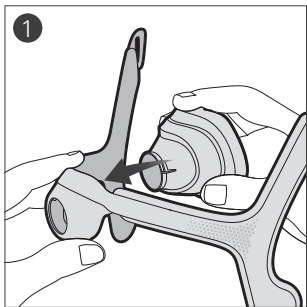

Cleaning your mask at home / 家中清潔面罩須知 /
家中清潔面罩須知 / Membersihkan bolong

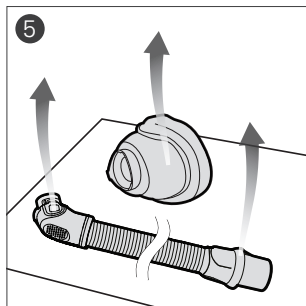
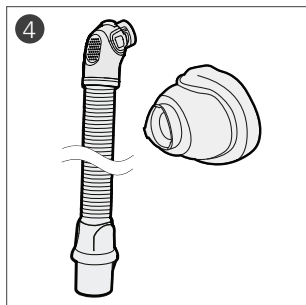
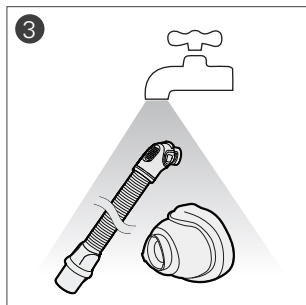
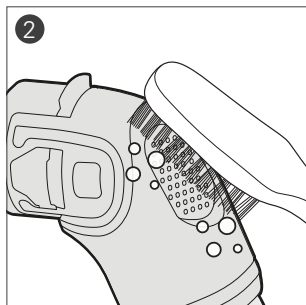
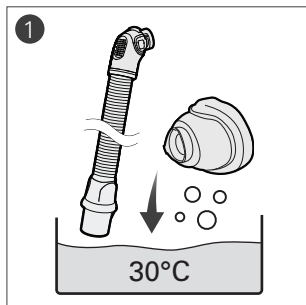



Nasal Mask

Thank you for choosing the AirFit N20. This document provides the user instructions for the AirFit N20 and AirFit N20 for Her masks referred to collectively as AirFit N20 throughout this manual.

Using this guide

Please read the entire guide before use. When following instructions, refer to the images at the front of the guide.

Intended use

The AirFit N20 channels airflow non-invasively to a patient from a positive airway pressure (PAP) device such as a continuous positive airway pressure (CPAP) or bilevel device.

The AirFit N20 is:

- to be used by patients weighing more than 30 kg for whom positive airway pressure has been prescribed
- intended for single-patient re-use in the home environment and multi-patient re-use in the hospital/institutional environment.

WARNING

Magnets are used in the lower headgear straps and the frame of the AirFit N20. Ensure the headgear and frame is kept at least 50 mm away from any active medical implant (eg, pacemaker or defibrillator) to avoid possible effects from localised magnetic fields. The magnetic field strength is less than 400 mT.

Contraindications

Use of masks with magnetic components is contraindicated in patients with the following pre-existing conditions:

- a metallic hemostatic clip implanted in your head to repair an aneurysm
- metallic splinters in one or both eyes following a penetrating eye injury.

GENERAL WARNINGS

- The vent holes must be kept clear.
- The mask should only be used with CPAP or bilevel devices recommended by a physician or respiratory therapist.
- The mask should not be used unless the device is turned on. Once the mask is fitted, ensure the device is blowing air. Explanation: CPAP and bilevel devices are intended to be used with special masks (or connectors) which have vent holes to allow continuous flow of air out of the mask. When the device is turned on and functioning properly, new air from the device flushes the exhaled air out through the mask vent holes. However, when the device is not operating, insufficient fresh air will be provided through the mask, and the exhaled air may be rebreathed. Rebreathing of exhaled air for longer than several minutes can, in some circumstances, lead to suffocation. This applies to most models of CPAP or bilevel devices.
- Follow all precautions when using supplemental oxygen.
- Oxygen flow must be turned off when the CPAP or bilevel device is not operating, so that unused oxygen does not accumulate within the device enclosure and create a risk of fire.
- Oxygen supports combustion. Oxygen must not be used while smoking or in the presence of an open flame. Only use oxygen in well ventilated rooms.
- At a fixed rate of supplemental oxygen flow, the inhaled oxygen concentration varies, depending on the pressure settings, patient breathing pattern, mask, point of application and leak rate. This warning applies to most types of CPAP or bilevel devices.
- The technical specifications of the mask are provided for your clinician to check that they are compatible with the CPAP or bilevel device. If used outside specification or if used with

incompatible devices, the seal and comfort of the mask may not be effective, optimum therapy may not be achieved, and leak, or variation in the rate of leak, may affect the CPAP or bilevel device function.

- Discontinue using this mask if you have ANY adverse reaction to the use of the mask, and consult your physician or sleep therapist.
- Using a mask may cause tooth, gum or jaw soreness or aggravate an existing dental condition. If symptoms occur, consult your physician or dentist.
- As with all masks, some rebreathing may occur at low CPAP pressures.
- Refer to your CPAP or bilevel device manual for details on settings and operational information.
- Remove all packaging before using the mask.
- The mask must be used under qualified supervision for users who are unable to remove the mask by themselves.
- This mask is not for use on patients with impaired laryngeal reflexes or other conditions predisposing to aspiration in the event of regurgitation or vomiting.
- Avoid connecting flexible PVC products (eg, PVC tubing) directly to any part of the mask. Flexible PVC contains elements that can be damaging to the materials of the mask, and may cause the components to crack or break.
- The mask contains an exhaust port safety feature to enable normal breathing. The mask should not be worn if this safety feature is damaged or missing.

Using your mask

When using your mask with ResMed CPAP or bilevel devices that have mask setting options, refer to the Technical specifications section in this user guide for the correct setting.

For a full list of compatible devices for this mask, see the Mask/Device Compatibility List on www.resmed.com/downloads/masks. If you do not have internet access, please contact your ResMed representative.

Fitting

1. Twist and pull both magnetic clips away from the frame.
2. With both lower headgear straps released, hold the mask against your face and pull the headgear over your head.

Headgear check:

Ensure that the ResMed logo on the headgear is facing outwards and is upright when the headgear is put on.

3. Bring the lower straps below your ears, and attach the magnetic clip to the frame.
4. Undo the fastening tabs on the upper headgear straps. Adjust the straps evenly until the mask sits comfortably just over the nose. Reattach the fastening tabs.
5. Undo the fastening tabs on the lower headgear straps. Adjust the straps evenly until the mask is stable. Reattach the fastening tabs.
6. Connect the device air tubing to the short tube. Attach the elbow to the mask by pressing the side buttons and pushing the elbow into the mask, ensuring it clicks in on both sides.
7. Your mask and headgear should be positioned as shown in the illustration.

Adjustment

If necessary, slightly adjust the position of the mask for the most comfortable fit. Ensure that the cushion is not creased and the headgear is not twisted.

1. Turn on your device so that it is blowing air.

Adjustment tips:

- ✓ To resolve any leaks at the upper part of the mask, adjust the upper headgear straps. For the lower part, adjust the lower headgear straps. Adjust only enough for a comfortable seal.
- ✓ The upper strap adjustment is the key to seal and comfort.
- ✓ Do not overtighten the lower straps because they mainly serve to keep the cushion in position.

Removal

1. Twist and pull both magnetic clips away from the frame.
2. Pull the mask away from your face and back over your head.

Disassembly

If the mask is connected to your device, disconnect the device air tubing from the short tube.

1. Undo the fastening tabs on the upper headgear straps. Pull the straps out of the frame.

Tip: Keep the magnetic clips attached to the lower headgear straps to easily distinguish the upper and lower straps when reassembling.

2. Remove the elbow from the mask by pressing the side button and pulling the elbow away.
3. Hold the frame by placing your thumb over the side slot. Pull the cushion away from the frame.

Reassembly

1. Push the cushion into the frame. The frame has a shape that allows you to insert the cushion only one way.
2. With the ResMed logo on the headgear facing outside and upright, thread the upper headgear straps into the frame slots from the inside. Fold them over to secure.

Cleaning your mask at home

It is important to follow the steps below to get the best performance out of your mask.

WARNING

- As part of good hygiene, always follow cleaning instructions and use a mild liquid detergent. Some cleaning products may damage the mask, its parts and their function, or leave harmful residual vapours that could be inhaled if not rinsed thoroughly.
- Regularly clean your mask and its components to maintain the quality of your mask and to prevent the growth of germs that can adversely affect your health.

CAUTION

If any visible deterioration of a system component is apparent (cracking, crazing, tears etc), the component should be discarded and replaced.

Daily/After each use:

Before cleaning, take the mask components apart according to the disassembly instructions.

1. Soak and agitate the cushion, multi-hole elbow and short tube in warm water (approximately 30°C) using a mild liquid detergent for up to 10 minutes.
2. Clean the components with a soft bristle brush, paying particular attention to the small vent holes on the multi-hole elbow.
3. Thoroughly rinse the components under warm flowing drinking quality water.
4. Inspect each component to ensure that they are visually clean and free of detergent residue. If required, repeat washing.
5. Allow the components to dry out of direct sunlight before assembling.

Weekly:

The magnetic clips can be left on for washing.

1. Soak and agitate the separated headgear and frame in warm water (approximately 30°C) using a mild liquid detergent for up to 10 minutes.
2. To rinse the components, repeatedly squeeze them under warm flowing drinking quality water until it is free of detergent residue.
3. Squeeze the components to remove excess water.
4. Allow the components to dry out of direct sunlight before assembling.

Reprocessing the mask between patients

Reprocess this mask when using between patients. Cleaning, disinfection and sterilisation instructions are available on www.resmed.com/downloads/masks. If you do not have internet access, please contact your ResMed representative.

Troubleshooting

| Problem/possible cause | Solution |
|--------------------------------|--|
| Mask is too noisy. | |
| Vent is dirty. | Clean the vent according to the instructions. |
| Mask is incorrectly assembled. | Disassemble the mask, then reassemble according to the instructions. |

| Problem/possible cause | Solution |
|--|--|
| Mask is leaking. | Refit or reposition your mask. Readjust the headgear straps to bring the mask closer to the face and improve your seal. Check that your mask is assembled correctly. |
| Mask leaks around face. | |
| Mask is not positioned correctly. | Check that the mask size indicator is facing downward on the bottom of the cushion along the bottom of your nose. |
| Mask may have been fitted incorrectly. | Pull the mask away from your face and reposition, ensuring that the lower corners of the mask fully enclose your nose. If necessary, readjust the headgear straps to keep the mask in the right place. |
| Cushion may be dirty. | Clean the cushion according to the instructions. |
| Cushion membrane is creased or folded. | Remove and refit your mask according to the fitting instructions. Ensure that you position the cushion correctly over your nose before pulling the headgear over your head. Do not slide the mask down your face during fitting as this may lead to folding or curling of the cushion. |
| Mask is not tightened correctly. | Ensure that the headgear straps are not overtightened or too loose. You may find that this mask does not need to be tightened as much as other nasal masks. Check that the headgear is not twisted. |
| Mask may be the wrong size. | Talk to your clinician. |
| Mask does not fit properly. | |
| Mask is incorrectly assembled. | Disassemble the mask, then reassemble according to the instructions. |
| Mask may be the wrong size. | Talk to your clinician. |

Technical specifications

Pressure-flow curve The mask contains passive venting to protect against rebreathing. As a result of manufacturing variations, the vent flow rate may vary.

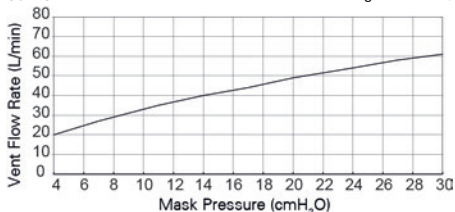

| Pressure (cm H ₂ O) | Flow (L/min) |
|--------------------------------|--------------|
| 4 | 20 |
| 7 | 27 |
| 11 | 35 |
| 14 | 40 |
| 17 | 44 |
| 20 | 49 |
| 24 | 54 |
| 27 | 58 |
| 30 | 61 |

Dead space information Physical dead space is the empty volume of the mask to the end of the swivel. Using the large cushions it is 103.3 mL.

Therapy pressure 4 to 30 cm H₂O

Resistance Drop in pressure measured (nominal)
at 50 L/min: 0.3 cm H₂O
at 100 L/min: 1.3 cm H₂O

Environmental conditions Operating temperature: 5°C to 40°C
Operating humidity: 15% to 95% non-condensing
Storage and transport temperature: -20°C to +60°C
Storage and transport humidity: up to 95% non-condensing

Sound DECLARED DUAL-NUMBER NOISE EMISSION VALUES in accordance with ISO 4871. The A-weighted sound power level of the mask is 24 dBA, with uncertainty of 3 dBA. The A-weighted sound pressure level of the mask at a distance of 1 m is 16 dBA, with uncertainty of 3 dBA.

Gross dimensions 339 mm (H) x 291 mm (W) x 162 mm (D)
Mask fully assembled with the short tube assembly and swivel, excluding the headgear

| | |
|---|---|
| International Commission on Non-Ionising Radiation Protection (ICNIRP) | Magnets used in this mask are within ICNIRP guidelines for general public use. |
| Service life | The service life of the AirFit N20 mask system is dependent on the intensity of usage, maintenance, and environmental conditions to which the mask is used or stored. As this mask system and its components are modular in nature, it is recommended that the user maintain and inspect it on a regular basis, and replace the mask system or any components if deemed necessary or according to the 'visual criteria for product inspection' in the 'Cleaning your mask at home' section of this guide. Refer to the 'Mask components' section of this guide for information of how to order replacement parts. |
| Mask setting options | For AirSense, AirCurve and S9: Select 'Pillows'. For other devices: Select 'SWIFT' (if available), otherwise select 'MIRAGE' as the mask option. |



Device Setting
Pillows

Notes:

- This product is not made with PVC, DEHP, DBP or BBP.
- This product is not made with natural rubber latex.
- The manufacturer reserves the right to change these specifications without notice.

Storage

















Ensure that the mask is thoroughly clean and dry before storing it for any length of time. Store the mask in a dry place out of direct sunlight.

Disposal

This mask does not contain any hazardous substances and may be disposed of with your normal household refuse.

Symbols

The following symbols may appear on your product or packaging:

| | | | |
|--|--|---|------------------------------------|
|  | Catalogue number |  | Batch code |
|  | Humidity limitation |  | Temperature limitation |
|  | Fragile, handle with care |  | Not made with natural rubber latex |
|  | Manufacturer |  | European Authorised Representative |
|  | Keep away from rain |  | This way up |
|  | Nasal mask |  | Device setting - Pillows |
|  | Size - small |  | Size - medium |
|  | Size - large | | |
|  | Indicates a Warning or Caution and alerts you to a possible injury or explains special measures for the safe and effective use of the device | | |
|  | Caution, consult accompanying documents | | |

Consumer Warranty

ResMed acknowledges all consumer rights granted under the EU Directive 1999/44/EC and the respective national laws within the EU for products sold within the European Union.

Warranty information for Australian customers

Our goods come with guarantees that cannot be excluded under the Australian Consumer Law. You are entitled to a replacement or refund for a major failure and for compensation for any other reasonably foreseeable loss or damage. You are also entitled to have the goods repaired or replaced if the goods fail to be of acceptable quality and the failure does not amount to a major failure.

In addition to your rights and remedies under Australian Consumer Law (and any other applicable law), ResMed Ltd ABN 30 003 765 142 of 1 Elizabeth Macarthur Drive, Bella Vista NSW 2153 (ResMed) warrants that your ResMed product will be free from defects in material and workmanship from the date of purchase for the period specified below.

| Product | Warranty period |
|---|-----------------|
| <ul style="list-style-type: none">Mask systems (including mask frame, cushion, headgear and tubing)—excluding single-use devicesAccessories—excluding single-use devicesFlex-type finger pulse sensorsHumidifier water tubs (non-reusable) | 90 days |
| <ul style="list-style-type: none">Batteries for use in ResMed internal and external battery systems | 6 months |
| <ul style="list-style-type: none">Clip-type finger pulse sensorsCPAP and bilevel device data modulesOximeters and CPAP and bilevel device oximeter adaptersHumidifiers and humidifier water tubs (reusable)Titration control devicesResMed Connectivity Module (RCM) | 1 year |

| Product | Warranty period |
|--|-----------------|
| <ul style="list-style-type: none"> • CPAP, bilevel and ventilation devices (including integrated humidifiers and external power supply units) • Battery accessories • Portable diagnostic/screening devices | 2 years |

To make a claim under this warranty you should contact the ResMed accredited outlet from which you purchased your ResMed product or send your claim to ResMed at 1 Elizabeth Macarthur Drive, Bella Vista NSW 2153 (phone number (02) 8884 1000) (email: reception@resmed.com.au). All claims under this warranty must be accompanied by your original receipt.

You will then need to deliver the ResMed product you claim is defective to the ResMed accredited outlet from which you purchased your ResMed product or your closest ResMed accredited outlet at your expense. A similar product will normally be lent to you by your ResMed accredited outlet while your product is assessed.

The product you claim as defective must be delivered from the ResMed accredited outlet to the ResMed Service Centre within the relevant warranty period referred to above. ResMed will not be responsible for the cost of the transport of your ResMed product to the ResMed Service Centre. You must pay any necessary costs to the ResMed accredited outlet. If ResMed determines that your warranty claim is valid, we will return the repaired product, or a replacement product, to your ResMed accredited outlet at ResMed's expense. If ResMed determines that your warranty claim is valid you may claim any reasonable expenses you have incurred in making the claim by posting to us at 1 Elizabeth Macarthur Drive, Bella Vista NSW 2153 a claim in writing attaching original receipts for the expenses claimed. If ResMed determines that your warranty claim is not valid, we will notify your ResMed accredited outlet by providing a quotation of the cost of repair. Your ResMed accredited outlet will then contact you and you will have the option of taking up the quotation offer, valid for 30 days, or have your product returned unrepaired to your ResMed accredited outlet at ResMed's expense.

This manufacturer's warranty is void on product sold, or resold, outside the region of original purchase. Manufacturer's warranty claims on defective product must be made by the initial consumer at the point of purchase or to us directly as specified above.

This warranty gives you specific legal rights. For further information on your warranty rights, contact your local ResMed dealer or ResMed office.

If you are provided with a replacement or repaired product, the warranty continues to apply to the replacement or repaired device but does not continue beyond the original warranty period referred to above.

If you have any questions or would like the address of your nearest ResMed accredited outlet, please contact our friendly customer service consultants.

Mask Components / 面罩组件 / 面罩組件 / Komponen topeng

| | | AirFit N20 | AirFit N20 for Her |
|----------|--|---------------------------------------|-------------------------------------|
| A | Elbow and short tube / 弯头和短管 / 彎頭和短管 / Siku dan tiub pendek | 63565 | 63565 |
| 1 | Elbow / 弯头 / 彎頭 / Siku | | |
| 2 | Side buttons / 侧按钮 / 側按鈕 / Butang sisi | | |
| 3 | Vent / 通气孔 / 通氣孔 / Bolong | | |
| 4 | Short tube / 侧按钮 / 側按鈕 / Tiub pendek | | |
| 5 | Swivel / 万向轴 / 萬向軸 / Pemutar ayun | | |
| B | Frame / 框架 / 框架 / Bingkai | 63566 | 63567 |
| C | Cushion / 护垫 / 護墊 / Kусyen | 63550 (S) 63551 (M) 63552 (L) | 63550 (S) 63551 (M) 63552 (L) |
| D | Headgear / 头带 / 頭帶 / Alat di kepala | 63560 (S) 63561 (Std) 63562 (L) | 63558 |
| 6 | Magnetic clips (2 pack) / 磁性夹 (2包) / 磁性夾 (2包) / Klip magnet | 63564 | 63564 |
| 7 | Lower headgear straps / 下部头带 / 下部頭帶 / Tali alat di kepala bahagian bawah | | |
| 8 | Upper headgear straps / 上部头带 / 上部頭帶 / Tali alat di kepala bahagian atas | | |

| | AirFit N20 | AirFit N20 for Her |
|---|---|--|
| A+B+C | | |
| Frame system / 框架系統 / 框架系統 / Sistem bingkai | 63553 (S) 63555 (M) 63556 (L) | 63554 (S) |
| A+B+C+D | | |
| Complete system / 完整系統 / 完整系統 / Sistem lengkap | ANZ: 63521 (M) 63522 (L) APAC: 63524 (M) 63525 (L) CHINA: 63529 (M) 63530 (L) | ANZ: 63520 (S) APAC: 63523 (S) CHINA: 63528 (S) |

S: Small / 小号 / 小號 / Kecil

M: Medium / 中号 / 中號 / Sederhana

L: Large / 大号 / 大號 / Besar

Std: Standard / 标准 / 標準 / Standard



ResMed

AirFit™ N20

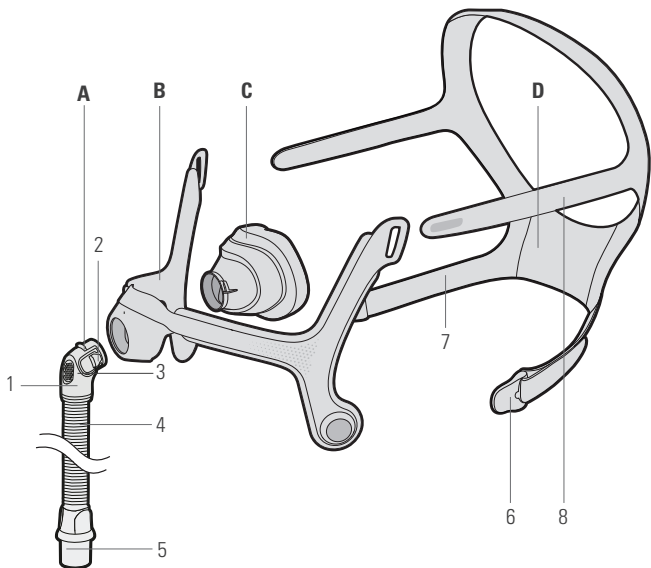

ResMed Ltd

MANUFACTURER 1 Elizabeth Macarthur Drive, Bella Vista NSW 2153 Australia

See ResMed.com for other ResMed locations worldwide. AirFit, AirSense and AirCurve are trademarks of the ResMed family of companies. For patent and other intellectual property information, see ResMed.com/ip.

© 2018 ResMed Ltd. 638151/1 2018-10

ResMed.com



638151